

Mission Statement:

To Study An Alternative Form To Harvest Energy By Means Of Road Application Using Piezoelectric Materials

Introduction

Why Use Piezoelectricity To Harvest Energy?

- Alternative Renewable Energy Source
- Long Lasting And Durable
- Energy Can Be Use Instantly Or Stored In Battery For Later Use
- Unique Actuation In Versatile Applications

Basic Concept

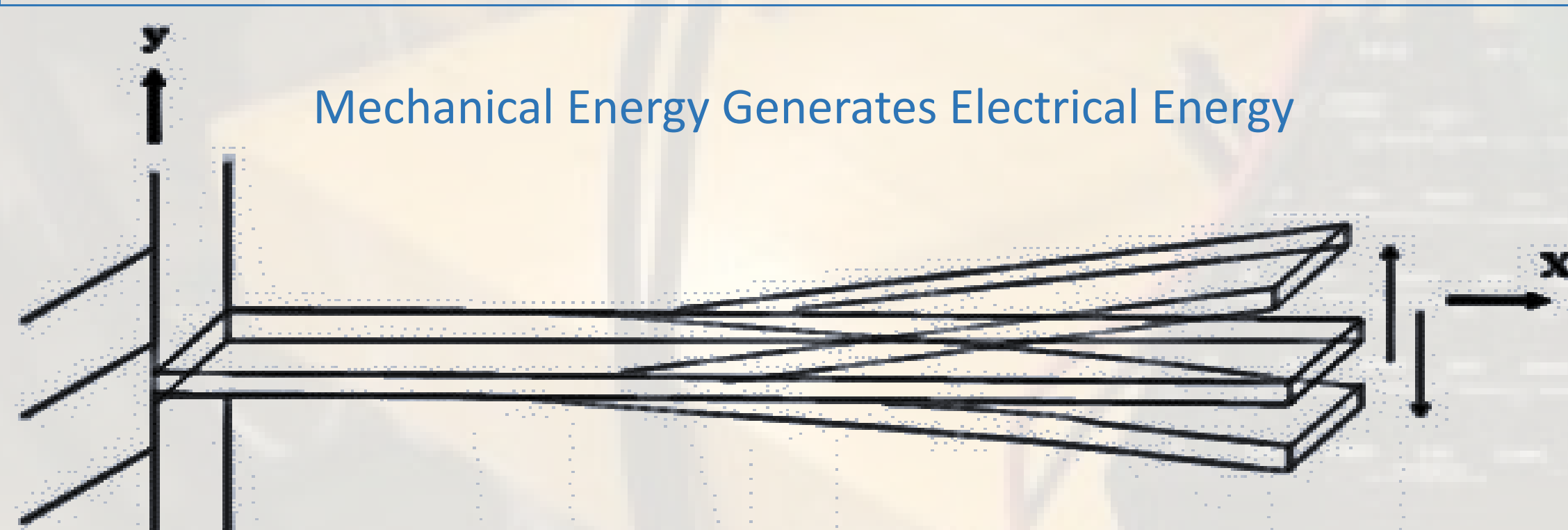

Conceptual Design

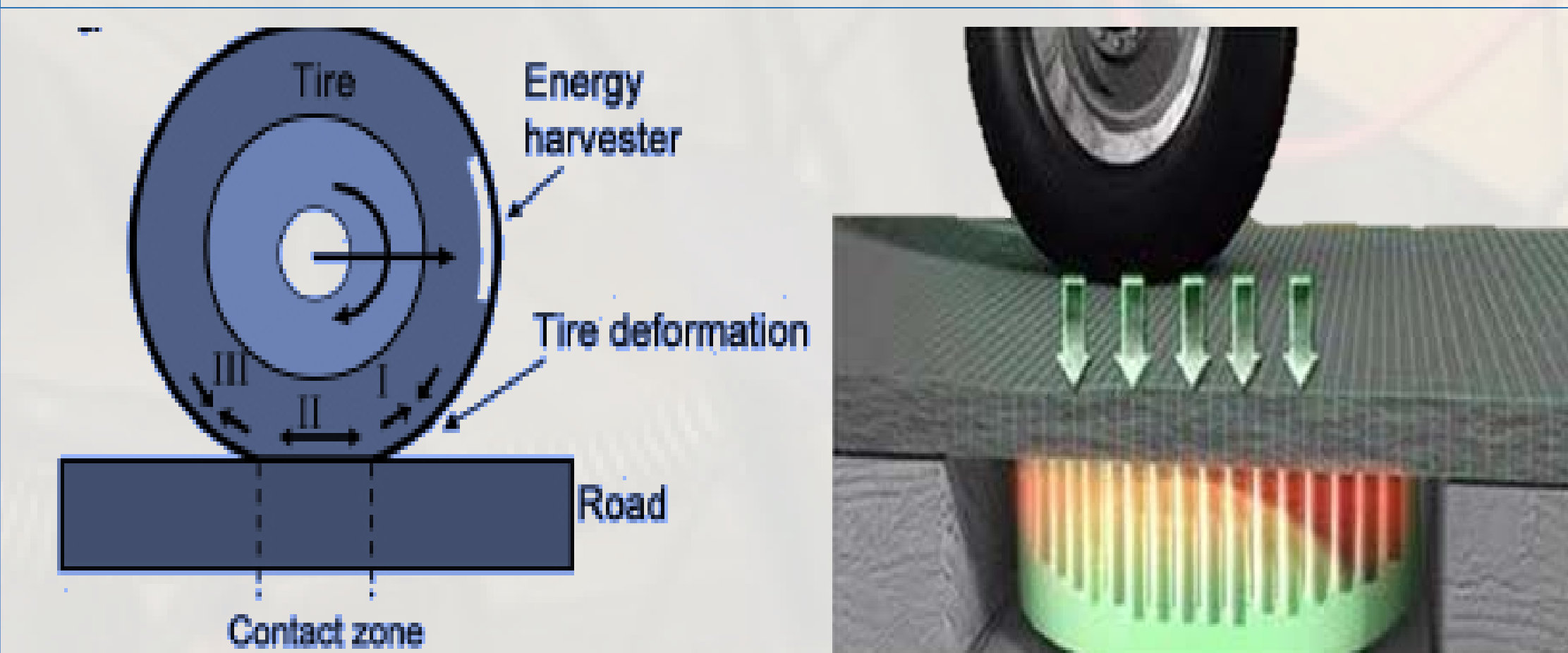

Vehicle Tire Transmits Weight Onto The Road Then To The Piezoelectric Components

Circuitry

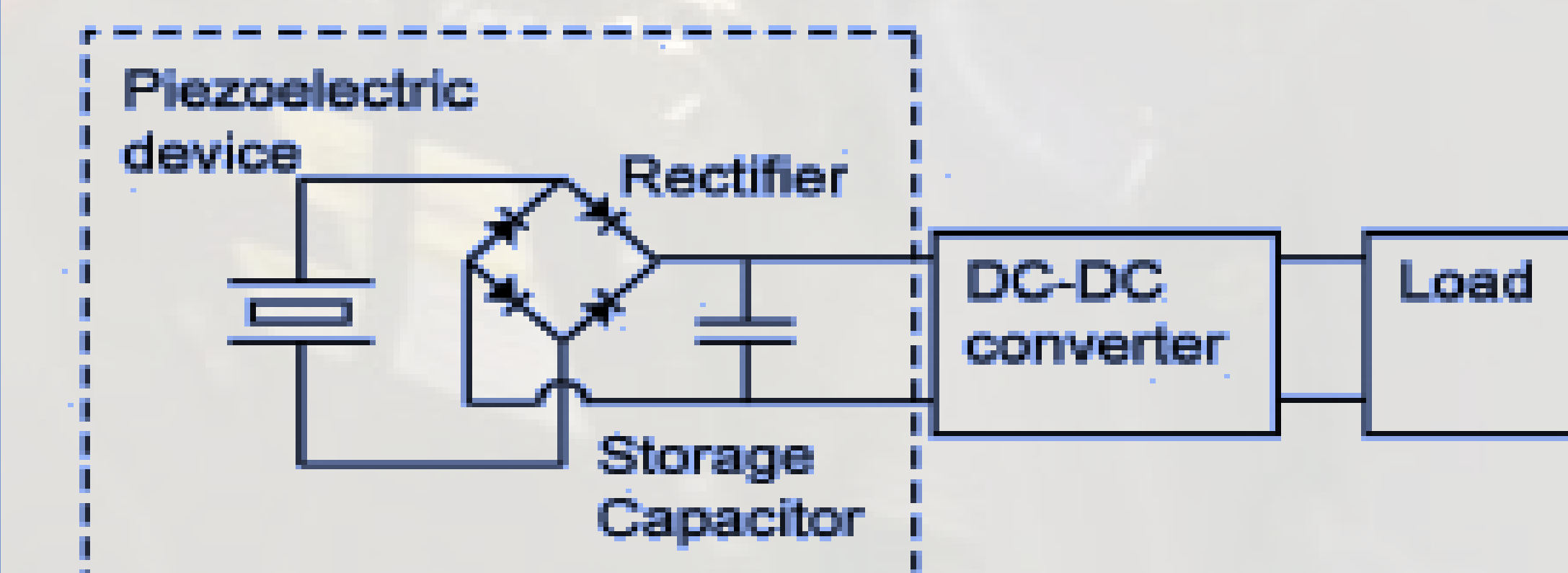

Design Challenges

- Concept Application
- Feasibility
- Mechanical Properties/System Vibration
- Determining proper material based on publication
- Determining proper material based on size
- Overcoming Low Current Output
- Proper Boundary Condition For Best Effective power output

Prototype



For Simplicity, LabView Software was not used since field testing was conducted outside of building.

Instrumentation:

- Oscilloscope
- Resistance Box
- Piezo Film sheets (8" x 11")

Attachments:

- Steel Plate (To Allow Vibration)
- Foam Panels (For protection)

Boundary Conditions:

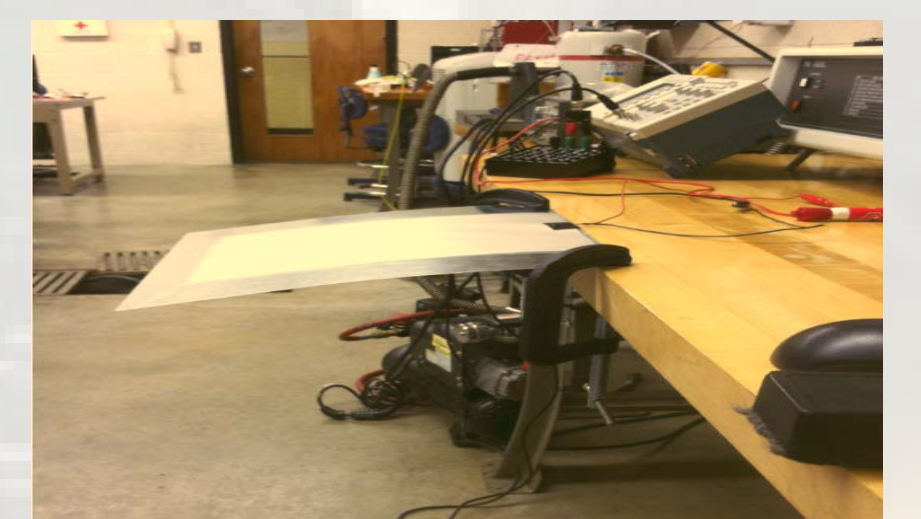

Cantilever Condition:

For This Orientation One Side Was Clamped To Simulating In Sided Fixed

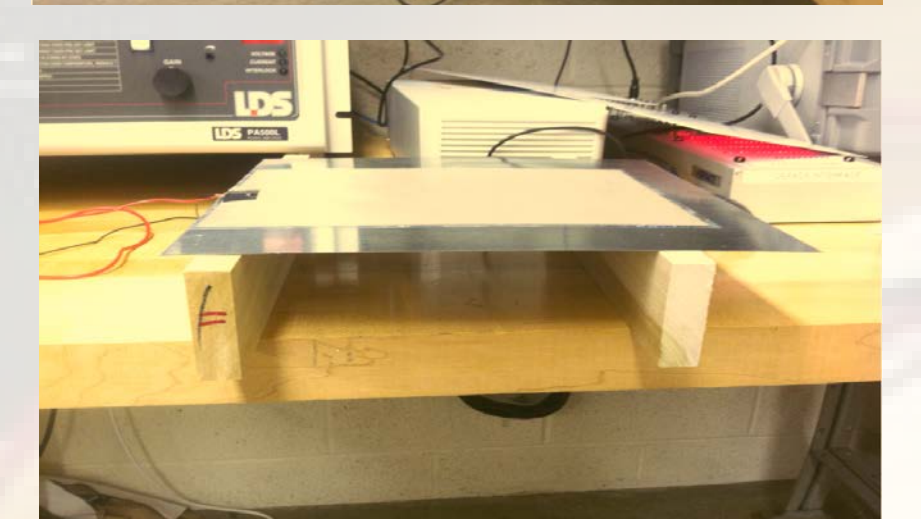

Simply Supported Condition:

Both Sides Were Left Free To Rotate And Have No Moment Resistance



Both Fixed Ends:

The Components Were Fixed At Both Ends Using Clamps On Both Ends, Restrained From Rotation



No Boundary:

The Components were left flat on the ground with no boundary conditions using self weight

Note: After The Four Boundaries Were Tested, The Output Voltage In Every Single Case showed A Result Peak Voltage of 4.81V From Which 3.40V Is Effective Voltage, Therefore For Simplicity No Boundaries Set Up Was Chosen

Voltage With Respect To Time

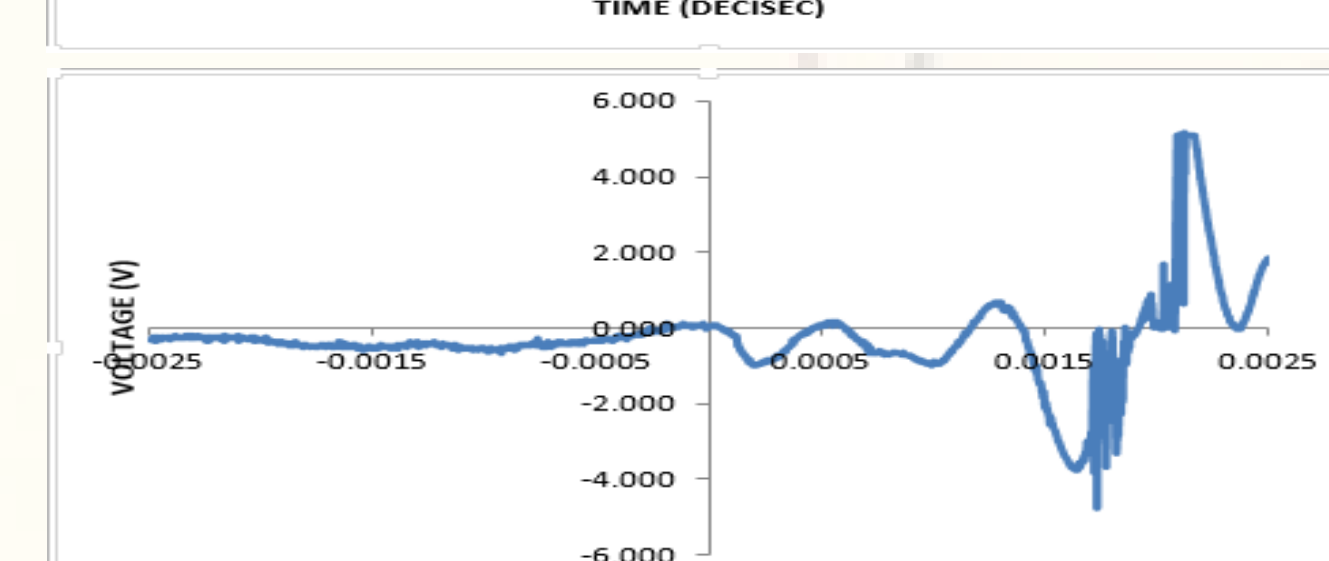
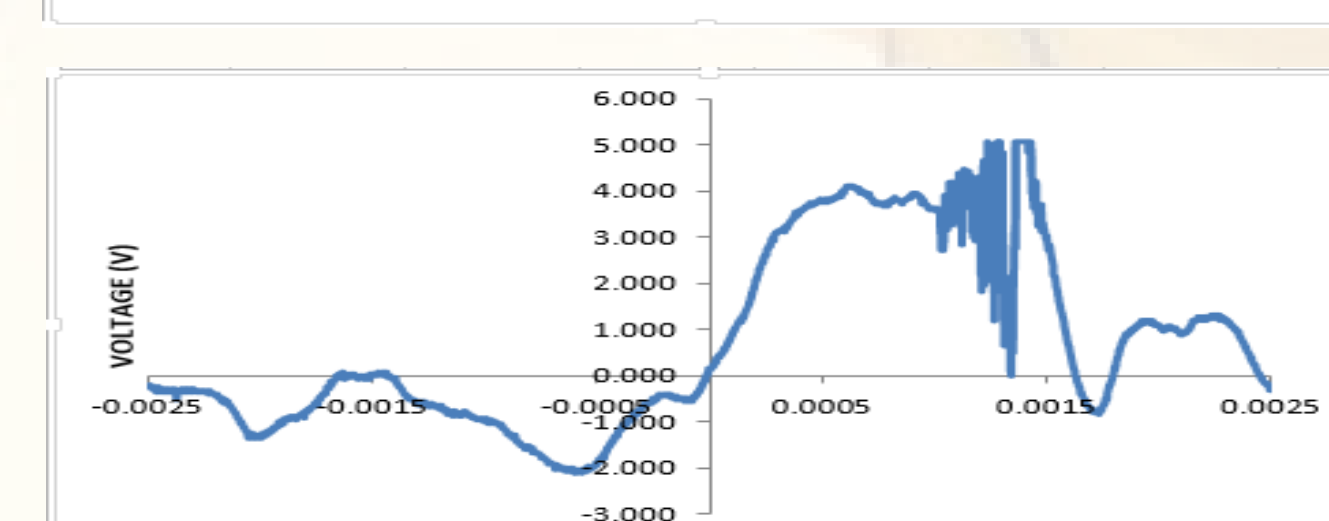
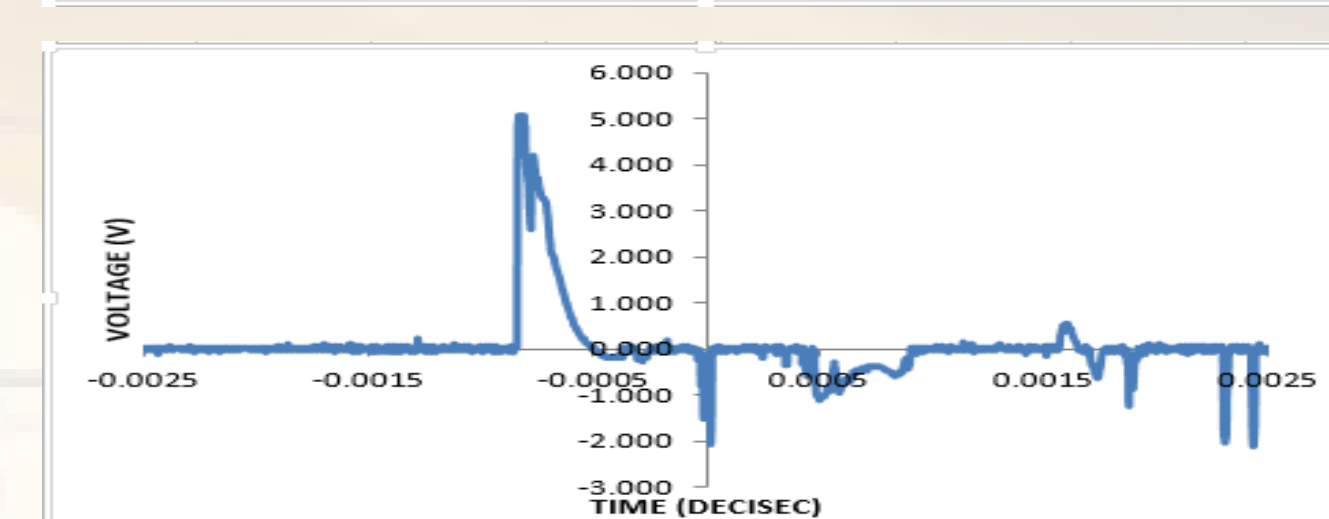
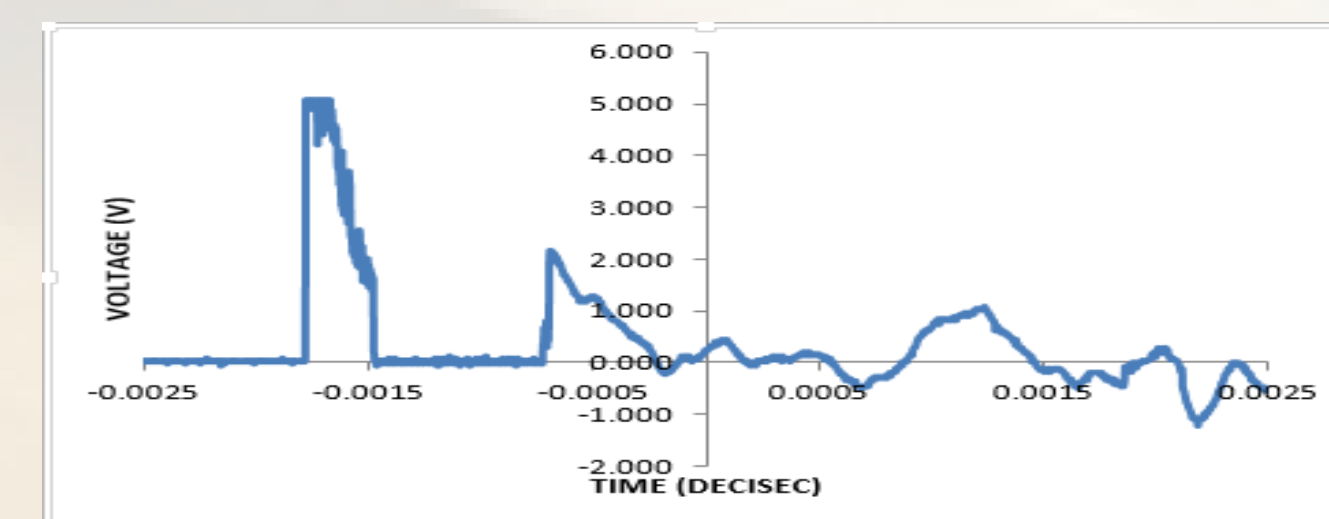

Initial Phase

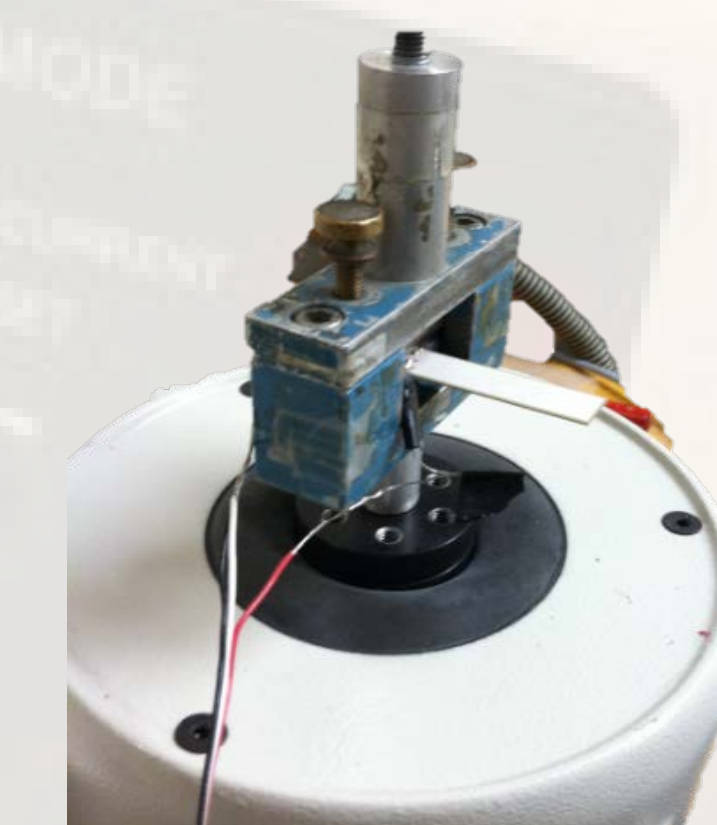

Instrumentation:

- LDS Shaking Unit
- Resistance Box
- Oscilloscope
- Generator Wiring
- Cantilever Beam PZT-5H (Lead Zirconate Titanate)
- LabView Software

Analysis

Material Dimensions And Properties Of Piezoelectric Cantilever Beam

Property	Symbol	Value
Length (mm)	L	35
Width (mm)	b	10
Structure thickness (mm)	t_s	0.1
Structure density (kg/m ³)	ρ_s	8960
PZT thickness (mm)	t_p	0.2
PZT density (kg/m ³)	ρ_p	7800
PZT modulus (GPa)	E_p	72
PZT dielectric constant	K_p^T	3500
PZT strain constant (m/V)	d_{31}	-270 $\cdot 10^{-12}$

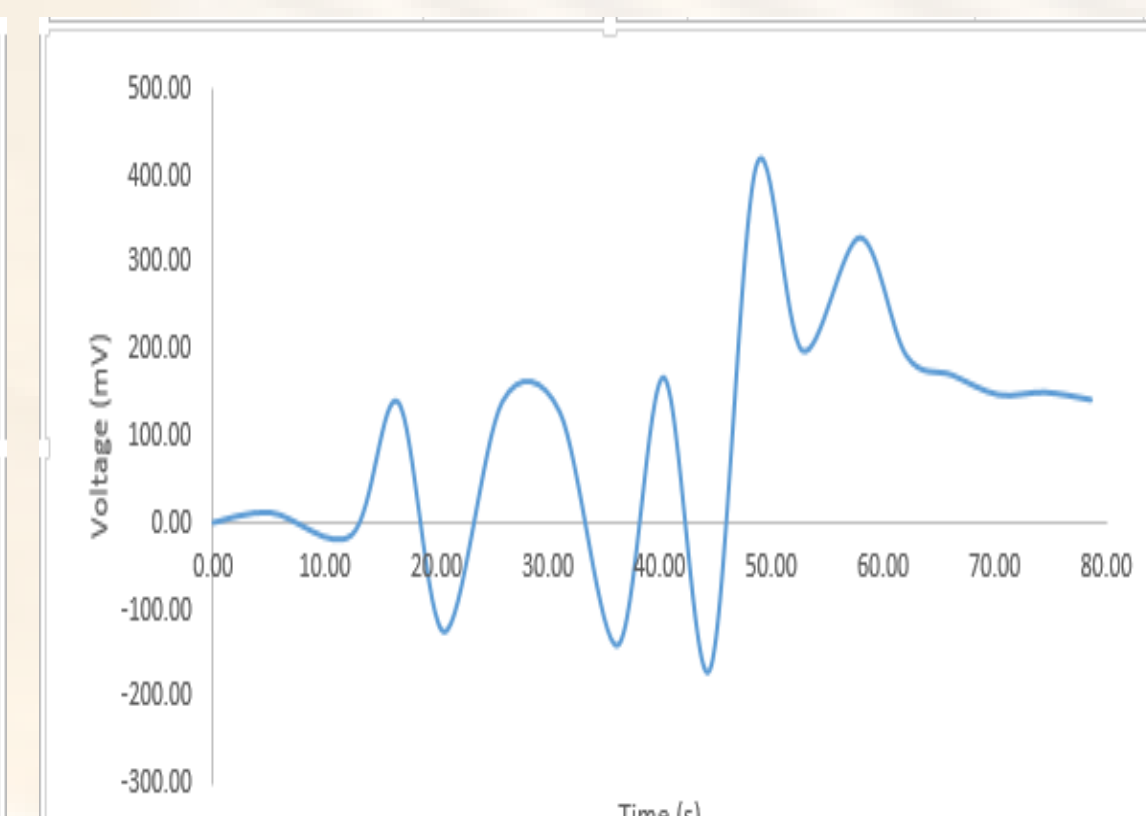
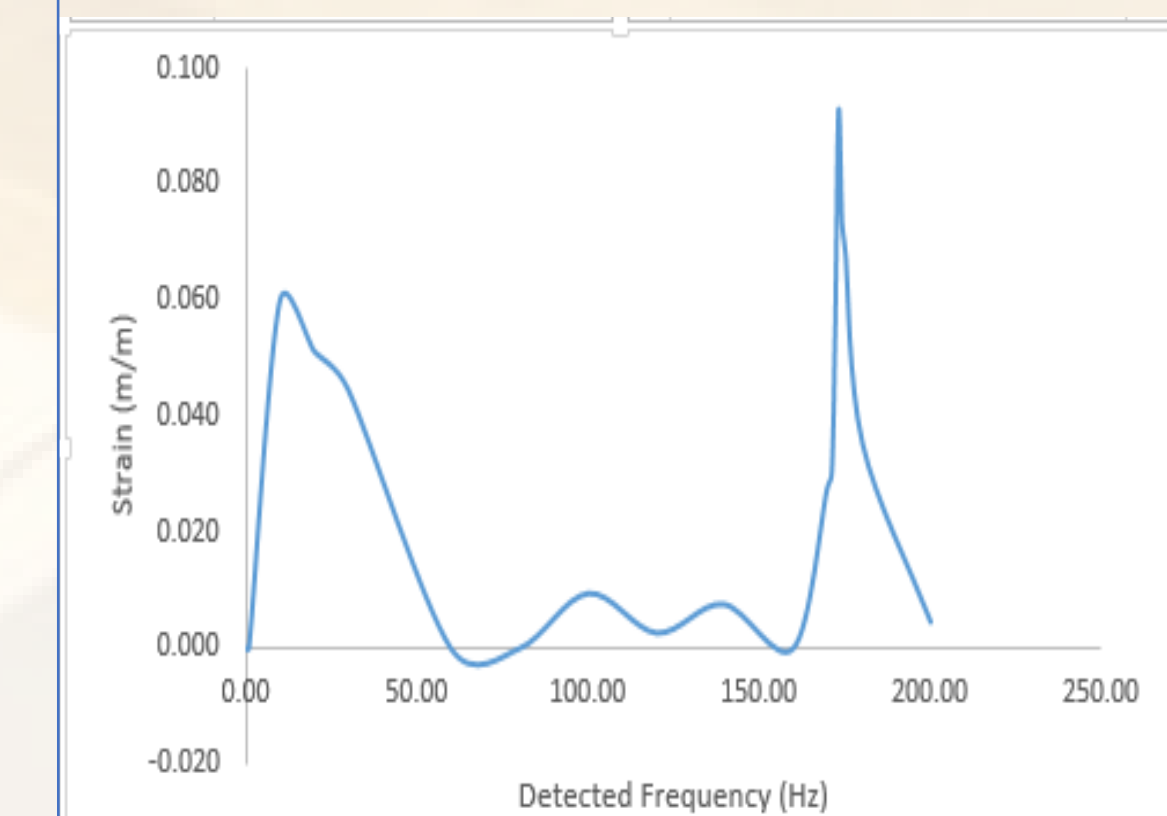
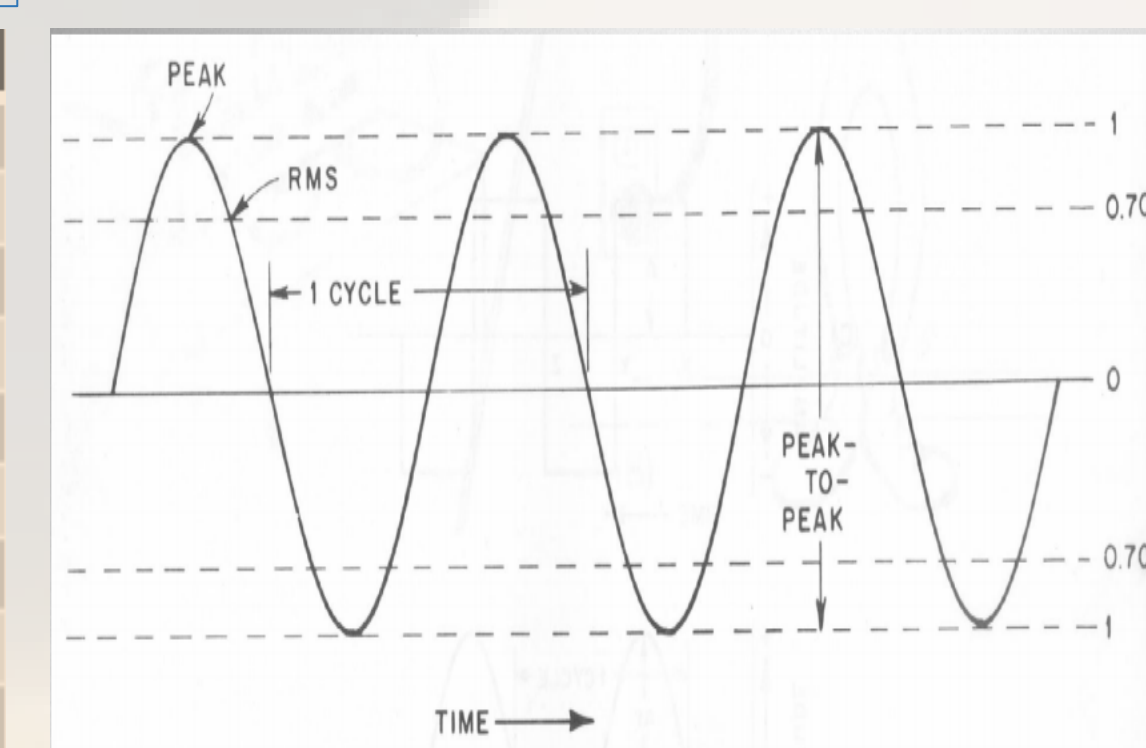

Tested Natural Frequency Agrees With Theoretical Natural Frequency At 170 Hz

Highest Effective Voltage Of 410mV Occurred At The Same Time (48.62s) As The Natural Frequency

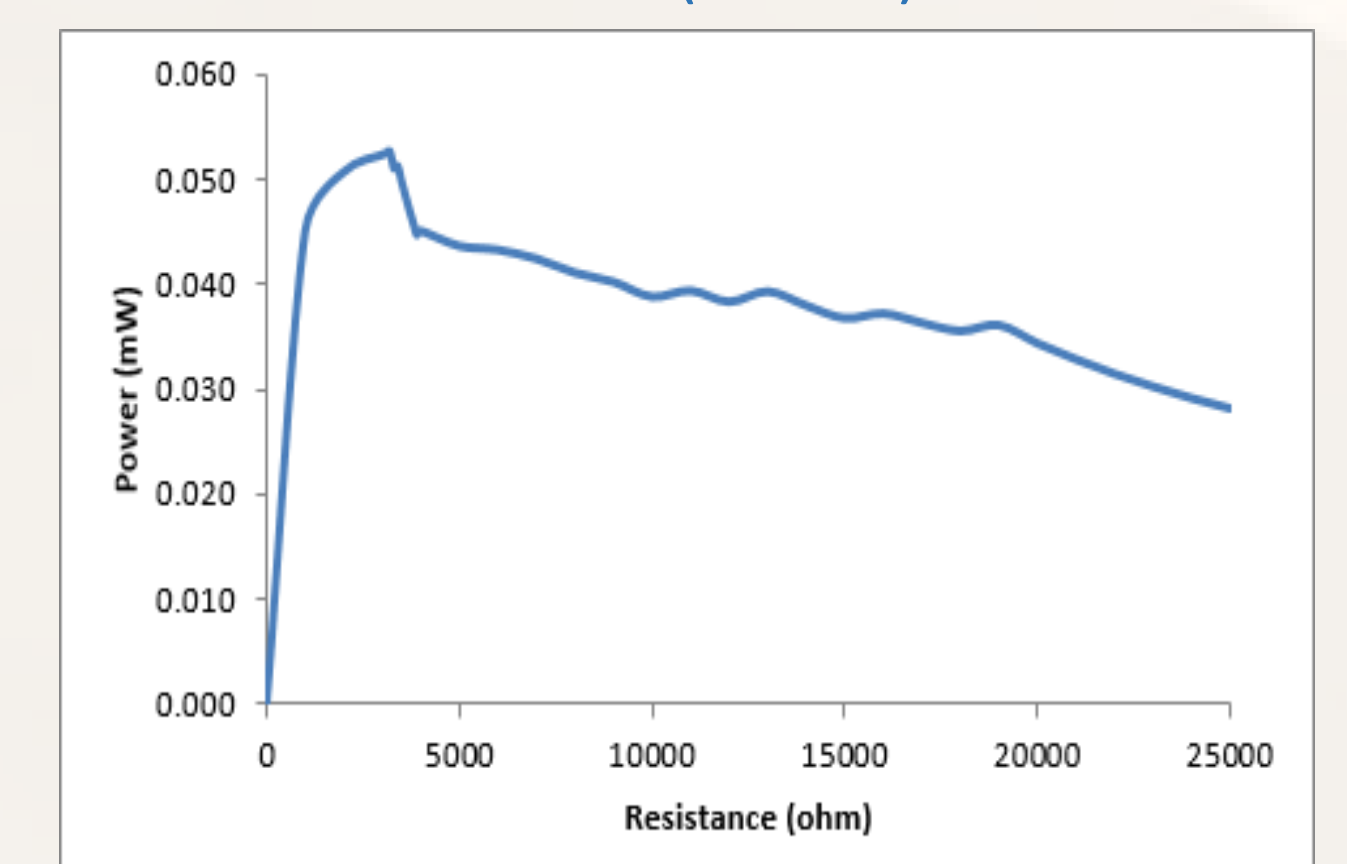

At The Highest Recorded Frequency, Different Levels Of Resistance Were Documented

Field Testing



Field Testing Was Performed at Buckman Hall By The Docking Area. The Following Vehicle Model Drove Over built Ramp Making A Stop And Go Simulation.

Results: Results Showed A Max Effective Voltage (RMS) of 3.59V At Which Depending On the Resistance Applied Could Reach A Maximum Power Output Of 12.9 Watts

Specifications	
LENGTH 43R.14in	WIDTH 49R.2in
HEIGHT 59R.6in	GROUND CLEARANCE 8R.7in
Body style illustration may not reflect the actual shape of this vehicle.	
EXTERIOR MEASUREMENTS	
WIDTH (FT)	6.17
LENGTH (FT)	15.63
HEIGHT (FT)	5.54
GROUND CLEARANCE (FT)	0.58
GROSS WEIGHT (LBS)	5051
DRIVE TYPE	ALL WHEEL DRIVE
TIRE WIDTH (FT)	0.75

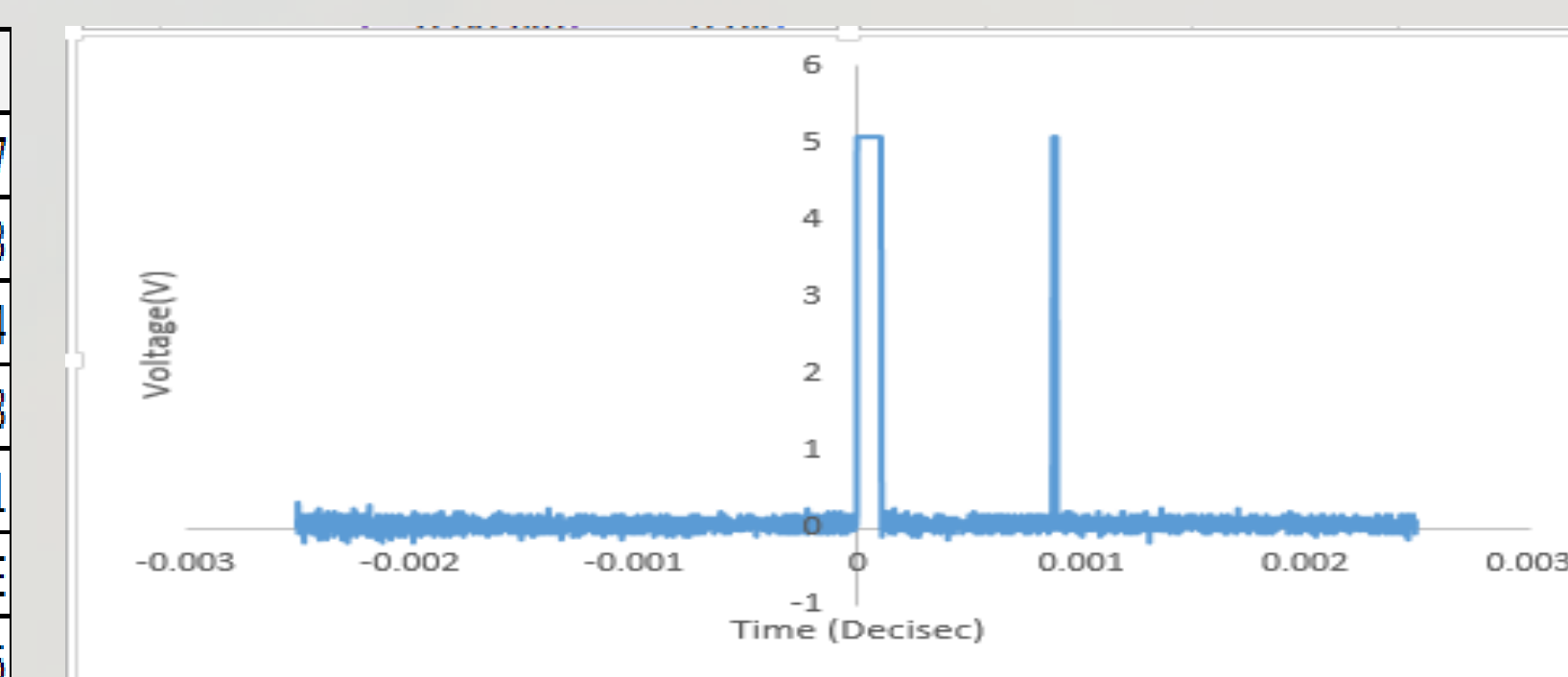

Future Work:

- Focus On Design To Allowed Proper Vibration And Therefore Generate Power For A Larger Time Frame
- Simulate A More Realistic Street Scenario
- The Use Of Different Vehicles

Acknowledgements:

Advisor: Dr Byungik Chang

Instrumental Assitance: Dr Samuel Daniels

Field Testing Area: Chief Of Police Mark DeLiето

Special Thanks To The SURF Program For Allowing me To be Part OF Such Outstanding Program.